

NOTICE DE MONTAGE POULAILLER MICHIGAN (Réf S2683)

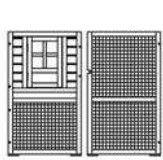

Panneau avant

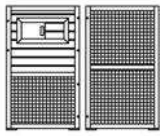

Panneau arrière

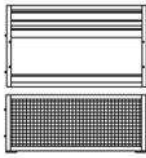

Panneau latéral gauche

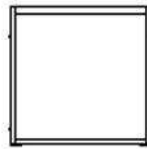

Panneau latéral droit

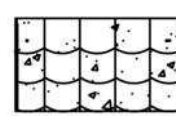

2 pans de toit

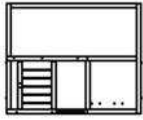

Panneau central



Panneau avant supérieur



Panneau arrière supérieur



Plancher abri



Tiroir de déjection



Rampe



2 Panneaux latéraux de pondoir



Panneau avant de pondoir



Plancher de pondoir



Toit de pondoir



Faitage



Perchoirs



3 séparations de pondoir

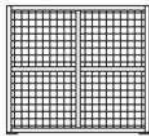

Panneau avant enclos

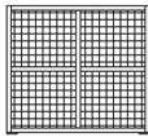

Panneau arrière enclos

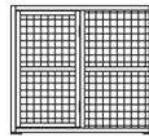

Panneau latéral enclos

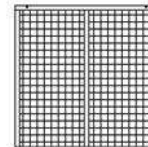

Panneau supérieur enclos

- (A) M6.0X55 8+1
- (B) M3.5X50 8+1
- (C) M3.5X45 28+1
- (D) M3.5X35 12+1
- (E) M3.0X25 4+1
- (F) M3.0X16 14+1
- (H) M3.0X14 8+1
- (G) M3.0X10 6+1
- x1
- 2 serrures

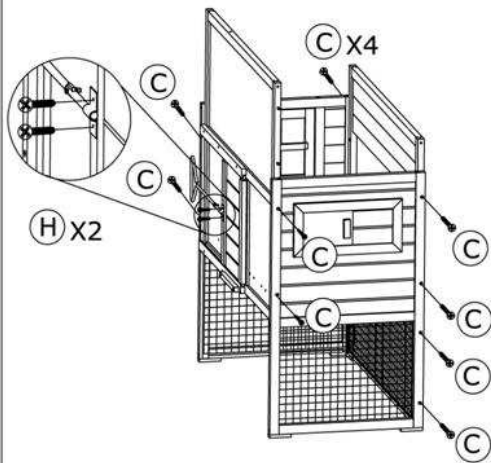

1. Assembler le panneau arrière droit avec le panneau latéral gauche, le panneau central et le panneau droit. Visser la clef métallique.

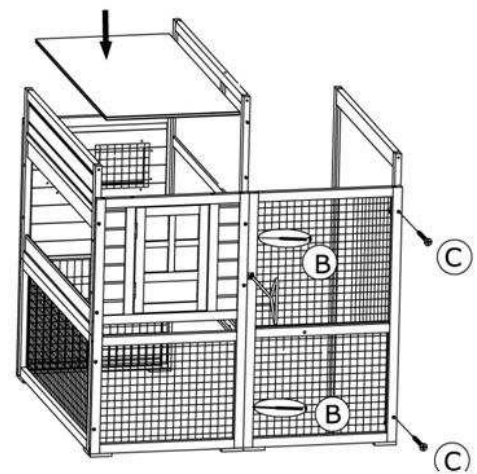

2. Assembler le panneau arrière droit et le panneau latéral droit puis insérer le plancher abri.

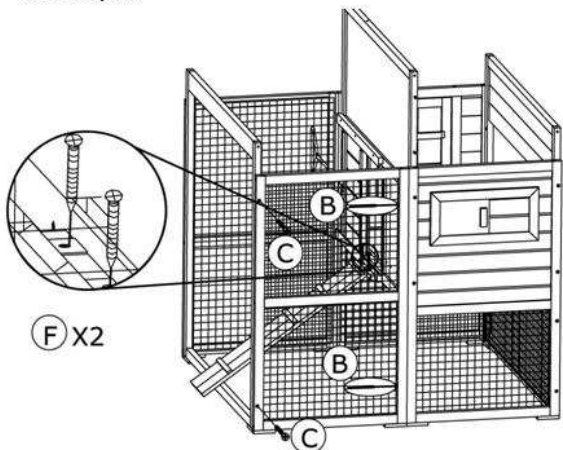

3. Assembler le panneau latéral arrière et le panneau arrière droit.

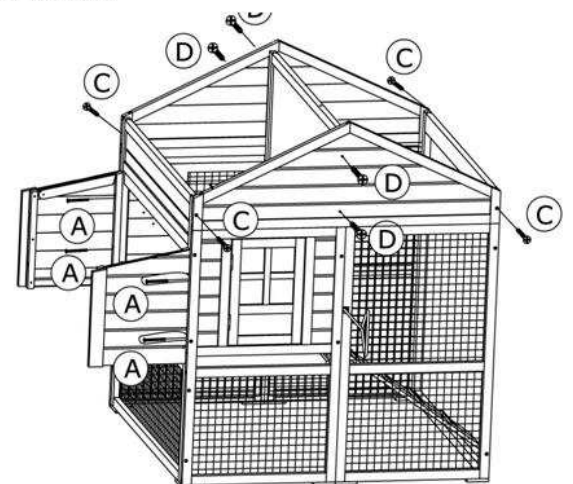

4. Assembler les panneaux avant et arrière supérieur et les 2 panneaux latéraux de pondoir.

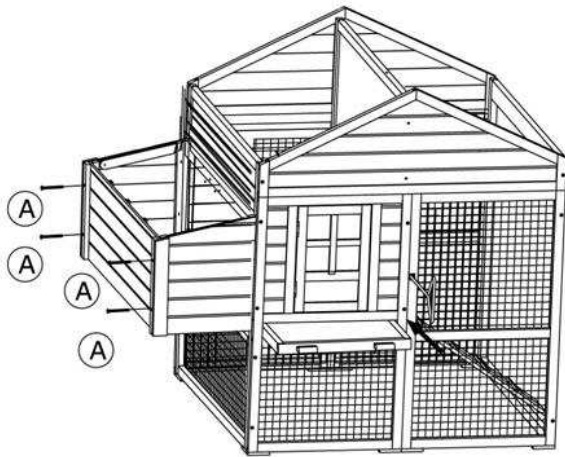

5. Fixer le panneau avant de pondoir et insérer le tiroir de déjection.

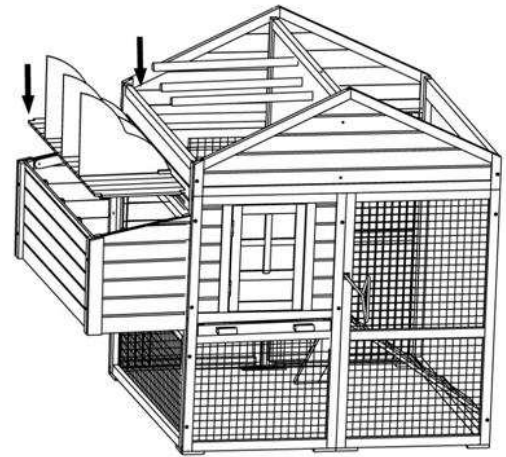

6. Insérer le plancher de pondoir, les séparations de pondoir et les perchoirs.

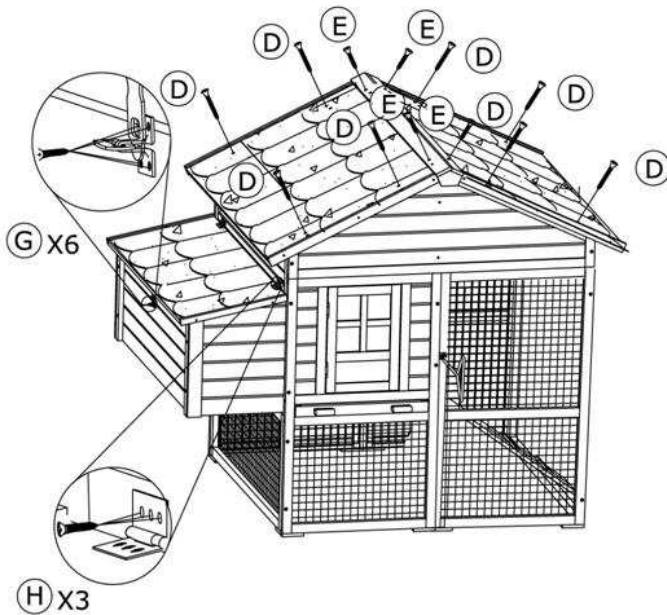

7. Assembler le toit du pondoir et le loquet de fermeture puis fixer les 2 pans de toit et le faîtage.

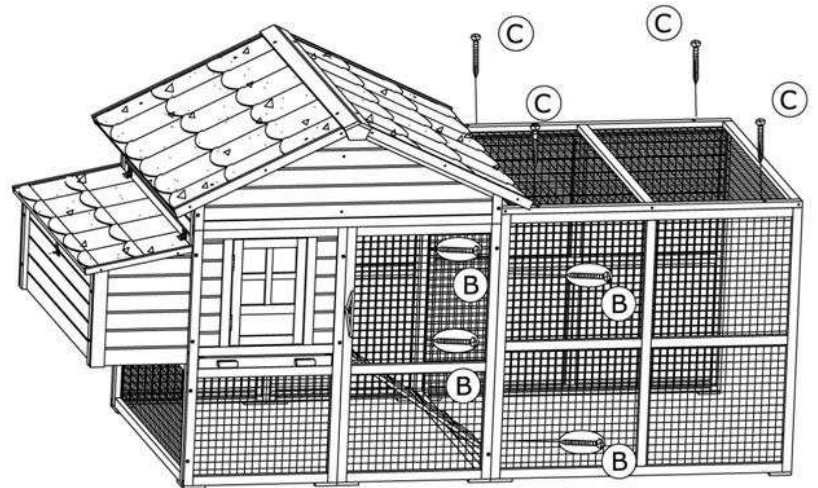

8. Fixer les panneaux avant, arrière et supérieur de l'enclos.

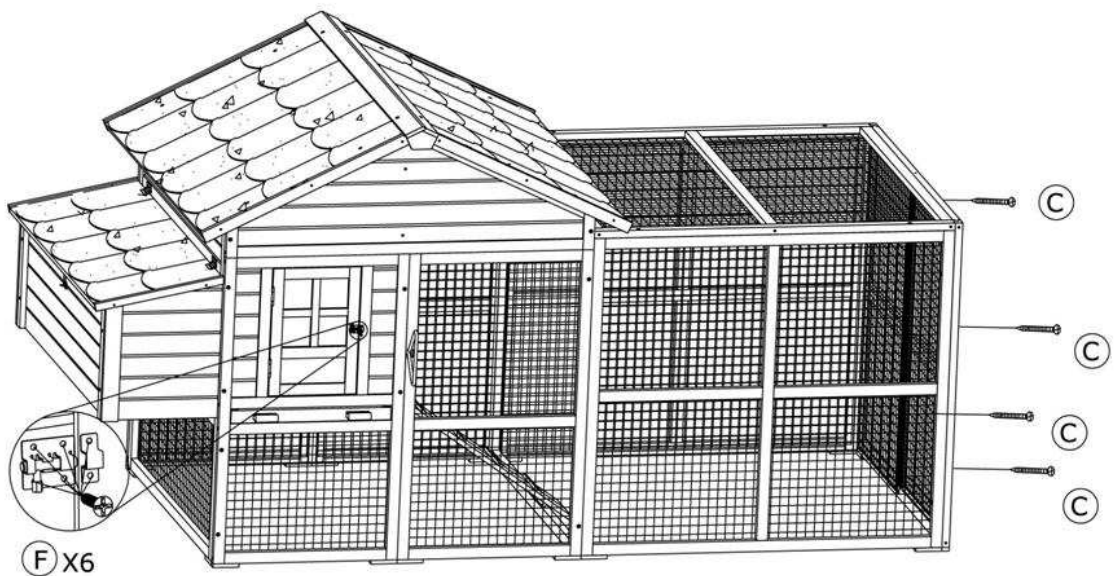

9. Fixer le panneau latéral de l'enclos et les serrures de porte.